

See discussions, stats, and author profiles for this publication at: <https://www.researchgate.net/publication/272474328>

Reduction of Vibrations of Pedestrian Bridges Using Tuned Mass Dampers (TMD)

Article in Archives of Acoustics · January 2010

Impact Factor: 0.57 · DOI: 10.2478/v10168-010-0015-3

CITATION

1

READ

1

1 author:



Wieslaw Fiebig

Wroclaw University of Science and Technol...

30 PUBLICATIONS 15 CITATIONS

SEE PROFILE

Reduction of Vibrations of Pedestrian Bridges Using Tuned Mass Dampers (TMD)

Wiesław FIEBIG

Wrocław University of Technology
Institute of Machine Design
Łukasiewicza 7/9, 51-377 Wrocław, Poland
e-mail: wieslaw.fiebig@pwr.wroc.pl

(received May 5, 2010; accepted May 19, 2010)

The reduction of structural vibrations on the example of two pedestrian bridges (in Poznań and Wrocław) with using of tuned mass dampers (TMD) has been presented in the paper. The results of theoretical and experimental studies of pedestrian bridge vibrations has been described and discussed. Basing on the results of calculations and measurements, tuned mass dampers (TMD) has been designed and mounted in the structure of the bridges. The measurements after the assembly of TMD show a high efficiency of vibration damping.

Keywords: pedestrian bridges, vibration, tuned mass dampers.

1. The design of the footbridge “Żabia Kładka” in Wrocław

The geometry of the bridge “Żabia kładka” in Wrocław and its view is shown in Fig. 1.

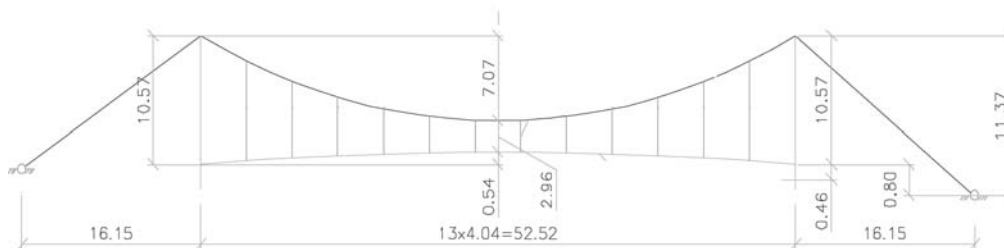

Fig. 1. The geometry of the footbridge “Żabia kładka” in Wrocław.

The concerned footbridge (Fig. 1), after it has been build, has meet the requirements of the static load written in the standard PN-85/S-10030. But the

dynamical behavior was not acceptable – the vibration amplitudes at the certain frequencies were too high. The correction of the dynamical behavior was required because of the discomfort in using the bridge. The correction concerns the possibility of damage the bridge in case of vandalism (BILISZCZUK *et al.*, 2003). Several methods have been taken into account and the tuned mass dampers (TMD) has been chosen as the most economic way to reduce excessive vibrations. Decisions regarding the installation of TMD has been taken after the identification of the vibration on the bridge and after performing a modal analysis.

2. Basic calculations

The calculation of the parameters of TMD as the effective mass, the stiffness of the spring elements, the tuning frequency and damping ratio can be determined basing on the two degree of freedom model shown in Fig. 2.

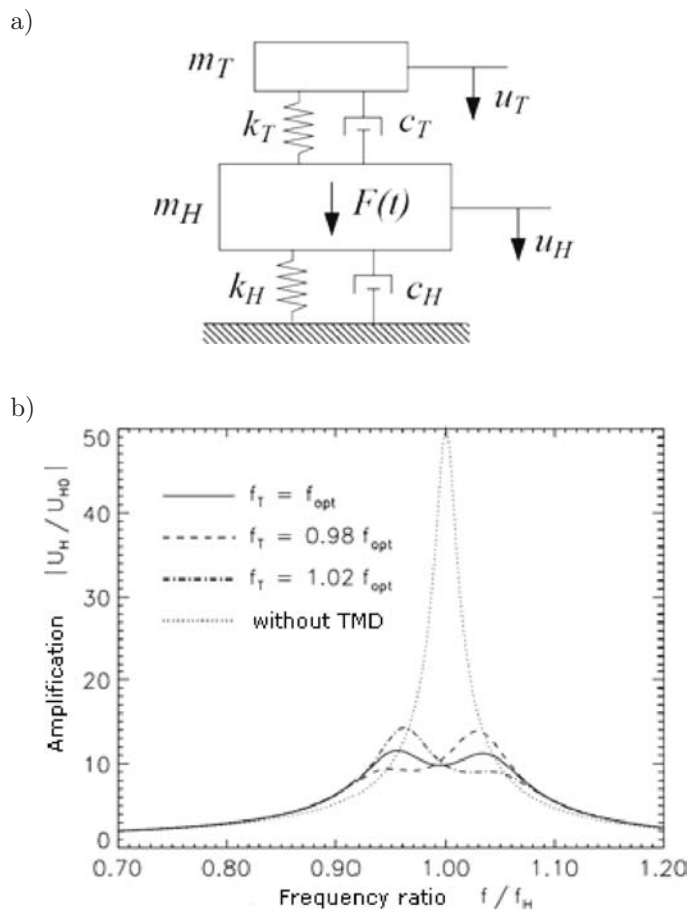

Fig. 2. The two mass system a) and b) amplification function for several tuning frequencies.

The equations of motion for the system shown in Fig. 2a are as follows:

$$\begin{aligned} m_H \ddot{u}_H + c_H \dot{u}_H + c_T (\dot{u}_H - \dot{u}_T) + k_H u_H + k_T (u_H - u_T) &= F(t), \\ m_T \ddot{u}_T + c_T (\dot{u}_T - \dot{u}_H) + k_T (u_T - u_H) &= 0. \end{aligned} \quad (1)$$

An amplification function can be established (DEN HARTOG, 1982; MEINHARDT *et al.*, 2008) using the equations of motion (1) applying an exponential approach (2), (3) and simplifying the equation using the terms displayed in (4).

$$u_T = U_T e^{i\omega t}, \quad F(t) = F_H e^{i\omega t}, \quad (2)$$

$$U_H + [-i\omega c_T - k_T] U_T = F_H, \quad (3)$$

$$[-i\omega c_T - k_T] U_H + [-\omega^2 m_T + i\omega c_T + k_T] U_T = 0,$$

$$\omega^2 \frac{m_H}{k_H} = \frac{\omega^2}{\omega_H^2} = \Omega^2,$$

$$\omega \frac{c_H}{k_H} = \omega \frac{2\zeta_H \omega_H m_H}{k_H} = 2\zeta_H \frac{\omega}{\omega_H} = 2\zeta_H \Omega,$$

$$\omega \frac{c_T}{k_H} = \omega \frac{2\zeta_T \omega_T m_T}{k_H} \frac{m_H}{m_H} = 2\zeta_T \frac{\omega_T}{\omega_H} \frac{\omega}{\omega_H} \frac{m_T}{m_H} = 2\zeta_T \beta \gamma \Omega, \quad (4)$$

$$\frac{k_T}{k_H} = \frac{\omega_T^2 m_T}{\omega_H^2 m_H} = \beta^2 \gamma,$$

$$\omega^2 \frac{m_T}{k_H} = \omega^2 \frac{m_T m_H}{m_H k_H} = \frac{\omega^2 m_T}{\omega_H^2 m_H} = \Omega^2 \gamma,$$

$$\frac{F_H}{k_H} = U_{H0}.$$

After introducing dimensionless terms (5) and identifying the natural frequencies ω_H , ω_T using (6), we are lead to the system of Eqs. (7). The latter can be used to calculate the amplification functions for the deflection U_{H0} under a static load F_H for several tuning frequencies.

$$\beta = \frac{\omega_T}{\omega_H} = \frac{f_T}{f_H}, \quad \gamma = \frac{m_T}{m_H}, \quad \zeta_H, \quad \zeta_T, \quad \Omega = \frac{\omega}{\omega_H}, \quad (5)$$

$$\omega_H = \sqrt{k_H/m_H}, \quad \omega_T = \sqrt{k_T/m_T}, \quad (6)$$

$$\begin{aligned}
 U_H + [-2i\Omega\beta\gamma c_T - \beta^2\gamma]U_T &= U_{H0}, \\
 [-2i\Omega\beta\gamma c_T - \beta^2\gamma]U_H + [-\Omega^2\gamma + 2i\Omega\beta\gamma c_T + \beta^2\gamma]U_T &= 0.
 \end{aligned}
 \tag{7}$$

Beside the tuning frequency f_T of the TMD and its damping ratio c_T , the efficacy of TMD strongly depends on the ratio between the structure mass and the TMD mass γ . Comparing the results, optimum values (minimum amplification) for the TMD parameters can be found. An example of results of such calculations has been shown in Fig. 3.

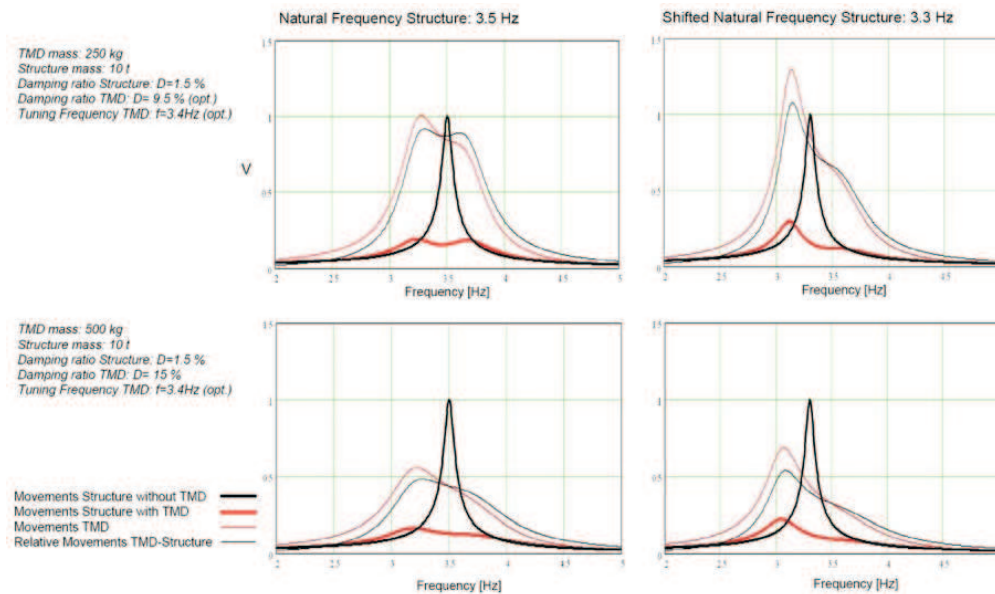

Fig. 3. Variation of TMD specifications and the resulting amplification functions (MEINHARDT *et al.*, 2008).

In order to change the dynamic behavior of the bridge system three TMD has been used. To reduce the vibrations at the natural frequency of 1.3 Hz, the mass of 935 kg has been installed at 1/4 and 3/4 length of the bridge and for the frequency of 1.4 Hz, the mass of 2310 kg has been installed in the middle of span.

3. Modal analysis

To obtain natural frequencies of the bridge, the experimental modal analysis has been performed. Figure 4 shows the first two vibration modes of the bridge resulting from the modal analysis.

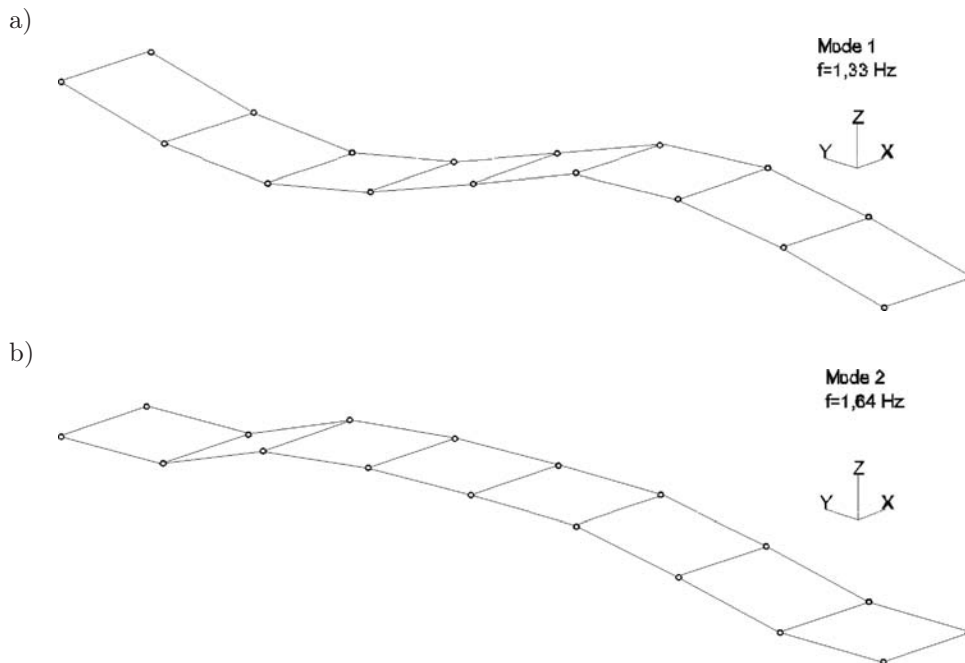

Fig. 4. The results of modal analysis, the measured figures of vibrations at frequencies:
a) 1.3 Hz, b) 1.6 Hz.

Each of the nodes shown in Fig. 4 is a vibration measuring point. Basing on the results of calculations and measurements, adopted design solutions of TMD and their parameters (mass, stiffness, number of springs and the design of the viscous damper) can be found. It should be noted that before the installation of TMD the bridge was very easy to excite. In evoking the bridge in the middle or at the $1/4$ and $3/4$ lengths by one or more people jumping, large vibration amplitudes exceeding 15 cm has been registered.

4. Description of the design of tuned mass dampers

The TMD consists mainly of the mass suspended on the spring elements and viscous dampers (DALMER *et al.*, 2004; RABIEGA, 2003, 2004). The frequency of natural vibrations of the TMD is tuned to the natural frequency of the bridge. The vibration of TMD occurs in an opposite phase to the vibration of the bridge.

The TMD (Figs. 5 and 6) consists of:

- a package of steel panels, which represents the vibrating mass. Due to many removable panels the fine tuning of the natural frequency of TMD to the natural frequency of the vibrations of the bridge is possible,
- arrangement of springs with certain stiffness,
- viscous dampers to provide damping in the system.

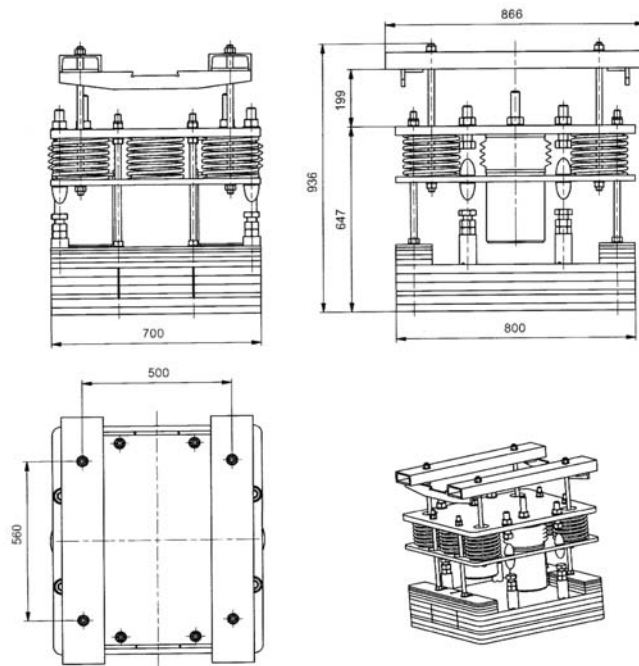

Fig. 5. The design of dampers mounted in the $1/4$ and $3/4$ of the bridge span.

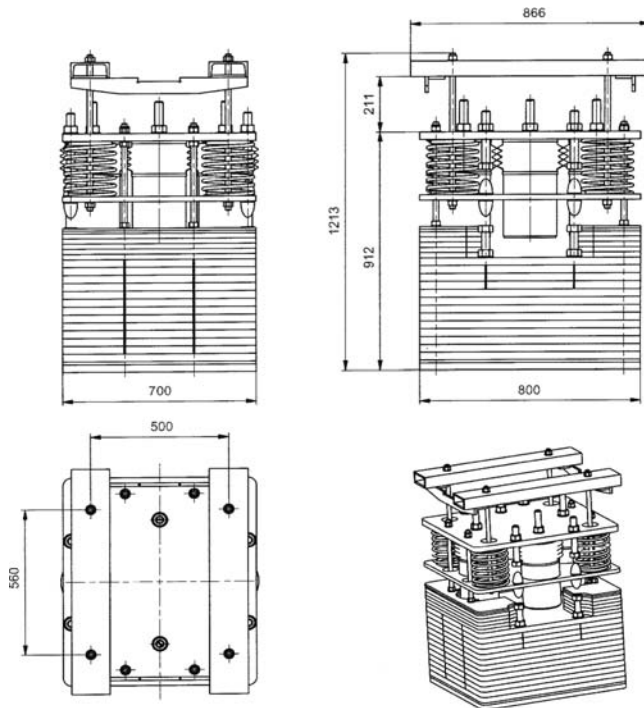
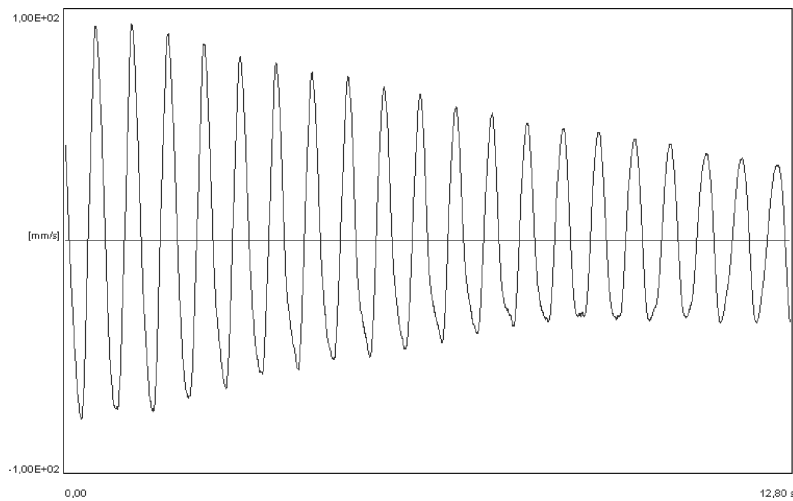

Fig. 6. The design of dampers mounted in the $1/2$ of the bridge span.

5. The reduction of vibrations

The TMD in a half span is used to damp the vibrations at the 2nd natural frequency; the dampers installed in 1/4 and 3/4 span serve to attenuate the 1st natural frequency (full sinus). In Fig. 7 the time courses of the vibration velocity of the bridge before and after installation of the mass dampers has been shown. As can be seen, the damping of vibrations after the installation of mass dampers is significantly higher than that of the bridge structure of the without TMD. Also the amplitudes of vibration velocity are relatively smaller at approximately the same excitation forces.

a)



b)

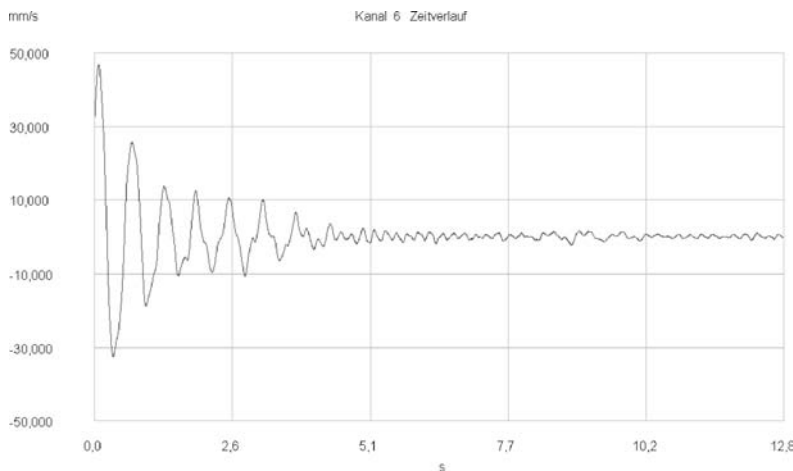

Fig. 7. The time courses of the vibration velocity of the bridge: a) before and b) after the installation of TMD.

6. The pedestrian bridge “Malta Center” in Poznań

The second installation of TMD from the GERB company has been done in Poznań at the Malta shopping center crossing over the Abp. Antoniego Baraniaka street (Fig. 8).



Fig. 8. View of the footbridge at the Malta Shopping Center in Poznań.

The curved in an arc of horizontal lengths footbridge consists of spans curved in horizontal lengths of 18.00, 67.50, 21.60, 15.50 [m]. The supporting structure (Fig. 9) consists of reinforced concrete with a prestressed beam construction – the main span of 67.5 m is suspended by means of 5 pairs of steel ropes of steel H-type of pylons.

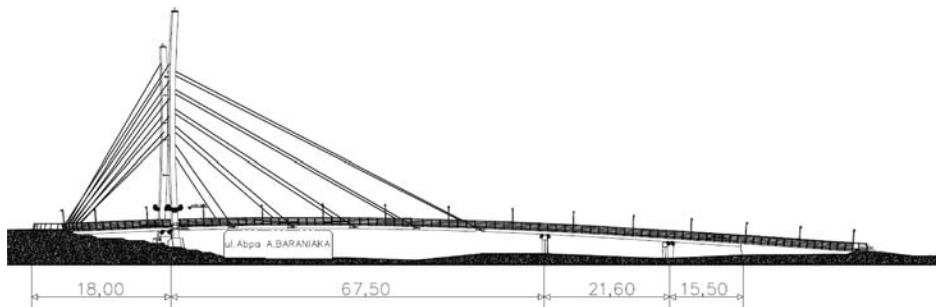

Fig. 9. The side view of the footbridge.

The investigations after the construction of the bridge have shown on the main span of 67 m a significant resonance frequency of 1 Hz. It was necessary to reduce the acceleration level of vibrations to a level below 1 m/s^2 . This is the limit value for the comfort in using pedestrian bridges. It has been achieved with use of two TMD with the approx. total mass of 5.6 tons (Fig. 10).



Fig. 10. TMD from GERB at Malta center in Poznań.

7. Conclusions

The dynamical behavior of pedestrian bridges, especially in case that is difficult to predict, can be improved by using tuned mass dampers. The parameters of the dampers like the mass, stiffness of the spring elements and required damping capability can be estimated by the computational method presented in this paper. Basing on two examples of pedestrian bridges installed in Wrocław and Poznań, it can be concluded that TMD was in both cases a most economical solution of the vibration reduction. In the examples shown, the TMD is acting in the vertical direction but it is also possible to install TMD for the reduction of vibration in the horizontal direction if it is required. TMD can be fully integrated in the bridge structure, especially when it is planned on the design stage.

References

1. BILISZCZUK J., HAWRYSZKÓW P., SZCZEPANIK K., STEMPIN P. (2003), *The acting of people crowd on pedestrian bridges*, [in Polish: *Działanie tłumu na kładki dla pieszych*], *Inżynieria i Budownictwo*, 8, 440–445.
2. DALMER F., FIEBIG W., RABIEGA J. (2004), *Vibration reduction of pedestrian bridges using tuned mass dampers*, [in Polish: *Redukcja drgań kładek dla pieszych z wykorzystaniem tłumików masowych*], V Krajowa Konf. Nauk.-Techniczna, Wrocław.
3. DEN HARTOG (1982), *Mechanical Vibration*, [in Polish: *Drgania mechaniczne*].
4. MEINHARDT CH., DRESSEN O., DALMER F. (2008), *Increase of the structural damping due to application of tuned mass dampers TMD subject to the footbridge construction*, *Footbridge*, 3rd Int. Conference, Portugal.
5. RABIEGA J. (2003), *Design project of damping system for Zabia Kładka by the Drobnera Street over the Odra River in Wrocław*, [in Polish: *Projekt wykonawczy systemu tłumiącego dla Żabiej Kładki nad rzeką Odra przy ul. Drobnera we Wrocławiu*], MOSTY, Ramiszów.
6. RABIEGA J. (2004), *Redesign of pedestrian bridge Zabia Kładka over the Odra River in Wrocław*, [in Polish: *Przebudowa kładki Żabiej przez Odrę we Wrocławiu*], *Inżynieria i Budownictwo*, 1–2.